

Toyo

Wear resistant pumps with agitator

**TECHNICAL SPECIFICATIONS
DPH PUMPS**

Performance curves

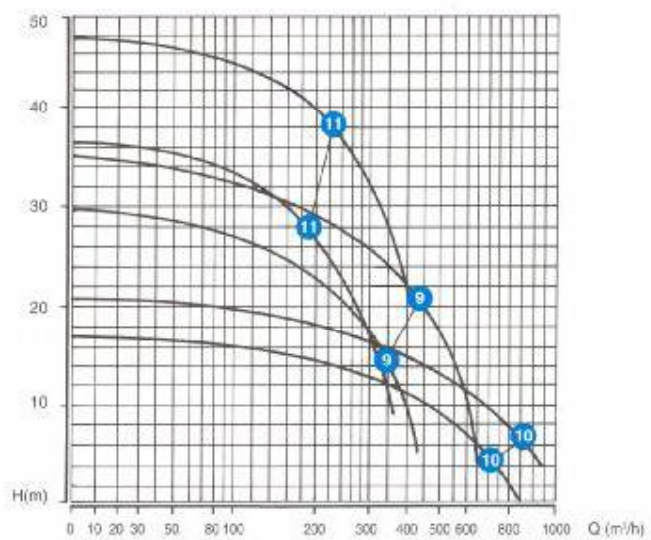
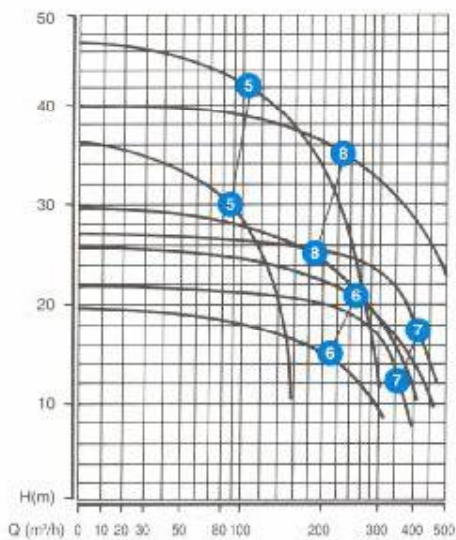
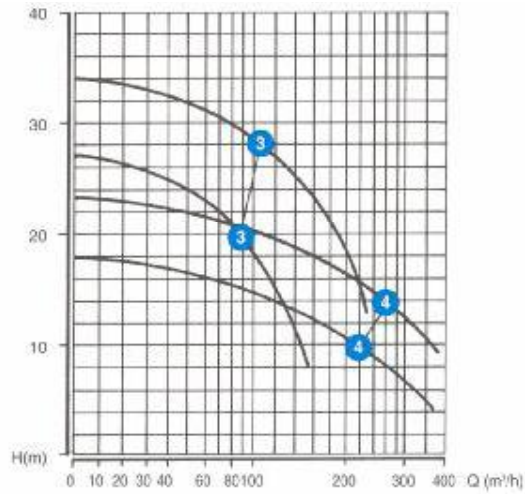
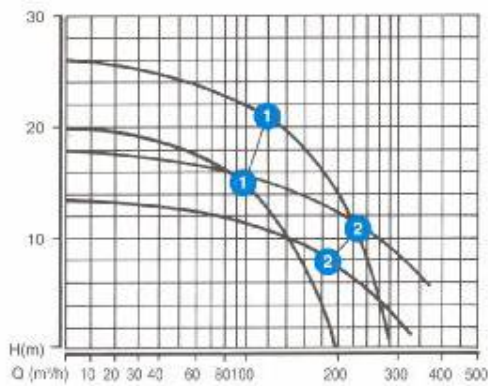

| Nr | Type | Outlet (inch)(mm) | | Capacity (m ³ /h) | | Manom. head (m) | | Particle size (mm) | Power (kW) | | Revolution (1/min) | | Weight (kg) |
|----|-----------|-------------------|-----|------------------------------|-----|-----------------|-----|--------------------|------------|------|--------------------|------|-------------|
| | | | | min | max | min | max | | min | max | min | max | |
| 1 | DPH 15 | 4 | 100 | 90 | 120 | 15 | 21 | 35 | 11 | 18.5 | 960 | 1150 | 360 |
| 2 | DPH 15B | 6 | 150 | 190 | 228 | 8 | 11 | 60 | 11 | 18.5 | 960 | 1150 | 380 |
| 3 | DPH 20 | 4 | 100 | 90 | 108 | 20 | 28 | 35 | 16 | 25.5 | 960 | 1150 | 385 |
| 4 | DPH 20B | 6 | 150 | 220 | 264 | 10 | 14 | 60 | 16 | 25.5 | 960 | 1150 | 405 |
| 5 | DPH 30 | 4 | 100 | 90 | 108 | 30 | 42 | 35 | 26 | 38 | 960 | 1150 | 590 |
| 6 | DPH 30B | 6 | 150 | 210 | 252 | 15 | 21 | 60 | 26 | 38 | 960 | 1150 | 570 |
| 7 | DPH 40B | 8 | 200 | 360 | 432 | 12 | 17 | 40 | 32 | 47 | 960 | 1150 | 580 |
| 8 | DPH 50 | 6 | 150 | 190 | 228 | 25 | 35 | 60 | 40 | 59 | 960 | 1150 | 660 |
| 9 | DPH 50B | 8 | 200 | 360 | 432 | 15 | 21 | 60 | 40 | 59 | 960 | 1150 | 680 |
| 10 | DPH 50BL | 10 | 250 | 720 | 864 | 5 | 7 | 100 | 40 | 59 | 960 | 1150 | 930 |
| 11 | DPH 50H | 6 | 150 | 190 | 223 | 28 | 38 | 40 | 40 | 59 | 960 | 1150 | 950 |
| 12 | DPH 100B | 8 | 200 | 360 | 428 | 30 | 42 | 60 | 86 | 129 | 740 | 880 | 1800 |
| 13 | DPH 100BL | 10 | 250 | 720 | 856 | 15 | 21 | 100 | 86 | 129 | 740 | 880 | 2200 |
| 14 | DPH 300 | 8 | 200 | 390 | 487 | 40 | 62 | 120 | 124 | 220 | 590 | 750 | 2900 |
| 15 | DPH 300L | 8 | 200 | 480 | 600 | 30 | 46 | 120 | 124 | 220 | 590 | 750 | 2900 |
| 16 | DPH 300B | 10 | 250 | 720 | 900 | 22 | 34 | 120 | 124 | 220 | 590 | 750 | 2940 |

Performance curves

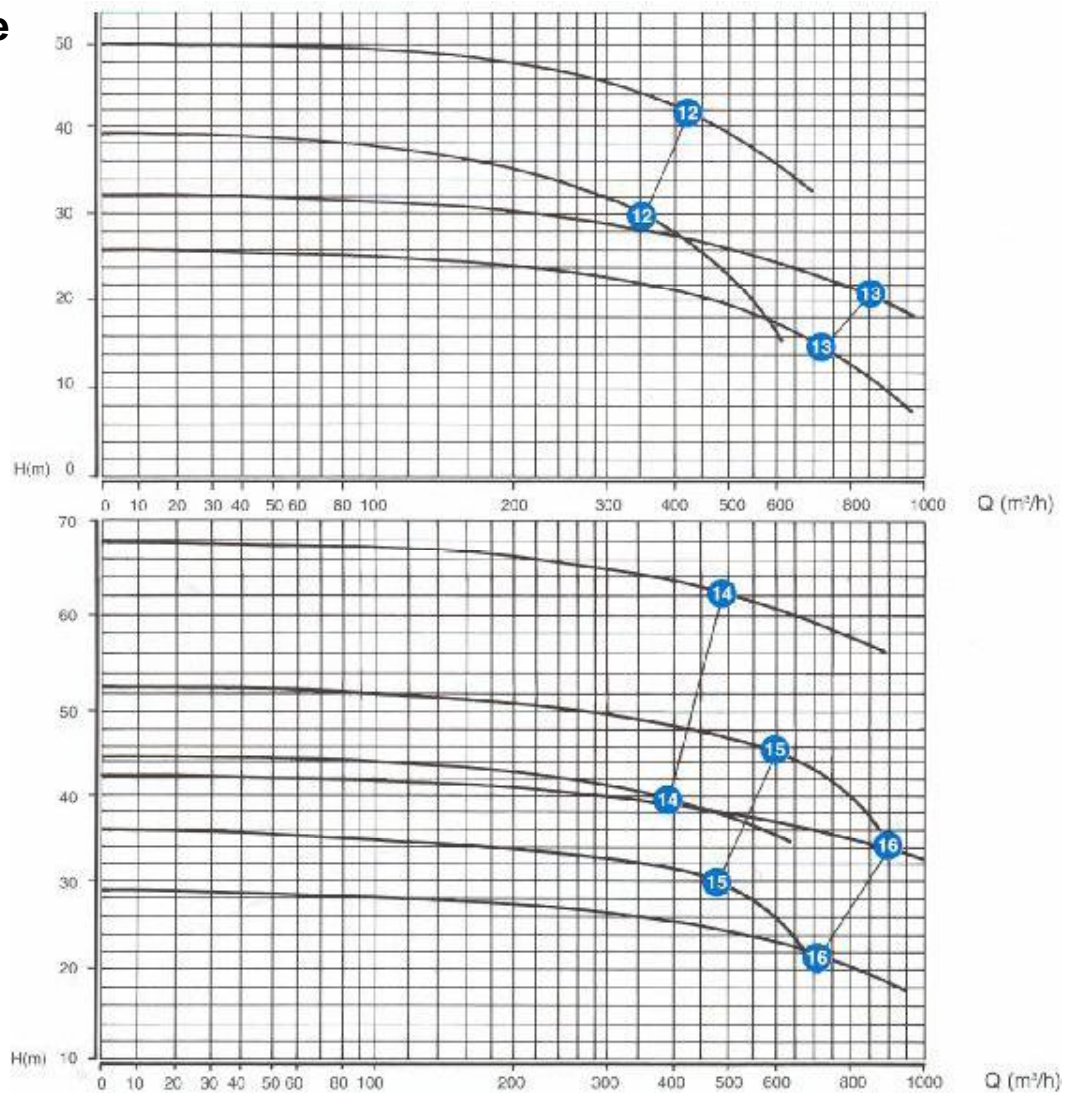

| Nr | Type | Hydr. motor Type | Revolution (1/min) | | Flow motor (l/min) | | Motor capacity CC | Motor press. (bar) | | Fittings SAE | | |
|----|-----------|-------------------|--------------------|------|--------------------|-----|-------------------|--------------------|-----|--------------|--------|----------|
| | | | min | max | min | max | | min | max | inlet | outlet | drain |
| 1 | DPH 15 | Volvo F12.40 | 960 | 1150 | 39 | 45 | 40 | 180 | 250 | 3/4" | 3/4" | 3/4"-16 |
| 2 | DPH 15B | Volvo F12.40 | 960 | 1150 | 39 | 45 | 40 | 180 | 250 | 3/4" | 3/4" | 3/4"-16 |
| 3 | DPH 20 | Volvo F12.60 | 960 | 1150 | 58 | 67 | 59.8 | 180 | 250 | 3/4" | 3/4" | 7/8"-14 |
| 4 | DPH 20B | Volvo F12.60 | 960 | 1150 | 58 | 67 | 59.8 | 180 | 250 | 3/4" | 3/4" | 7/8"-14 |
| 5 | DPH 30 | Volvo F12.80 | 960 | 1150 | 78 | 90 | 80.4 | 180 | 250 | 1" | 1" | 7/8"-14 |
| 6 | DPH 30B | Volvo F12.80 | 960 | 1150 | 78 | 90 | 80.4 | 180 | 250 | 1" | 1" | 7/8"-14 |
| 7 | DPH 40B | Volvo F12.110 | 960 | 1150 | 110 | 127 | 110.1 | 210 | 250 | 1 1/4" | 1 1/4" | 3/4" BSP |
| 8 | DPH 50 | Volvo F12.110 | 960 | 1150 | 110 | 127 | 110.1 | 210 | 250 | 1 1/4" | 1 1/4" | 3/4" BSP |
| 9 | DPH 50B | Volvo F12.110 | 960 | 1150 | 110 | 127 | 110.1 | 210 | 250 | 1 1/4" | 1 1/4" | 3/4" BSP |
| 10 | DPH 50BL | Volvo F12.110 | 960 | 1150 | 110 | 127 | 110.1 | 210 | 250 | 1 1/4" | 1 1/4" | 3/4" BSP |
| 11 | DPH 50H | Volvo F12.110 | 960 | 1150 | 110 | 127 | 110.1 | 210 | 250 | 1 1/4" | 1 1/4" | M33x2 |
| 12 | DPH 100B | Rexroth A2FM M355 | 740 | 880 | 275 | 320 | 355 | 210 | 300 | 1 1/2" | 1 1/2" | M33x2 |
| 13 | DPH 100BL | Rexroth A2FM M355 | 740 | 880 | 275 | 320 | 355 | 210 | 300 | 1 1/2" | 1 1/2" | M33x2 |
| 14 | DPH 300 | Rexroth A2FM M500 | 590 | 750 | 308 | 386 | 500 | 177 | 300 | 1 1/2" | 1 1/2" | M33x2 |
| 15 | DPH 300L | Rexroth A2FM M500 | 590 | 750 | 308 | 386 | 500 | 177 | 300 | 1 1/2" | 1 1/2" | M33x2 |
| 16 | DPH 300B | Rexroth A2FM M500 | 590 | 750 | 308 | 386 | 500 | 177 | 300 | 1 1/2" | 1 1/2" | M33x2 |

DIMENSIONS AND OTHER TECHNICAL INFORMATION **Toyo**

| DIMENSIONS | A | B | C | D | E | F | G | H | I | J |
|--------------|------|-----|-------|-------|-----|-----|-----|------|-------|------|
| 1 DPH 15 | 1087 | 500 | 350 | 260 | 280 | 197 | 300 | 445 | 500 | 750 |
| 2 DPH 15B | 1087 | 560 | 330 | 280 | 280 | 197 | 300 | 445 | 560 | 841 |
| 3 DPH 20 | 1104 | 495 | 345 | 265 | 280 | 214 | 300 | 515 | 495 | 825 |
| 4 DPH 20B | 1104 | 560 | 330 | 280 | 280 | 214 | 300 | 445 | 560 | 841 |
| 5 DPH 30 | 1165 | 515 | 365 | 280 | 280 | 240 | 360 | 635 | 515 | 910 |
| 6 DPH 30B | 1165 | 580 | 350 | 295 | 280 | 240 | 360 | 510 | 580 | 955 |
| 7 DPH 40B | 1189 | 580 | 350 | 295 | 280 | 264 | 360 | 510 | 600 | 1010 |
| 8 DPH 50 | 1274 | 635 | 405 | 325 | 280 | 264 | 360 | 560 | 635 | 1020 |
| 9 DPH 50B | 1274 | 635 | 405 | 325 | 280 | 264 | 360 | 560 | 655 | 1065 |
| 10 DPH 50BL | 1349 | 760 | 462.5 | 342.5 | 280 | 264 | 360 | 560 | 762.5 | 1350 |
| 11 DPH 50H | 1279 | 650 | 420 | 315 | 280 | 264 | 360 | 660 | 650 | 1094 |
| 12 DPH 100B | 1810 | 695 | 445 | 415 | 600 | 350 | 520 | 760 | 695 | 1570 |
| 13 DPH 100BL | 1993 | 840 | 540.5 | 502.5 | 600 | 350 | 520 | 820 | 840.5 | 1645 |
| 14 DPH 300 | 2270 | 940 | 640 | 634 | 600 | 396 | 520 | 1010 | 940 | 1610 |
| 15 DPH 300L | 2330 | 970 | 640 | 634 | 600 | 396 | 520 | 1010 | 940 | 1610 |
| 16 DPH 300B | 2330 | 970 | 670 | 664 | 600 | 396 | 520 | 1010 | 970 | 1695 |

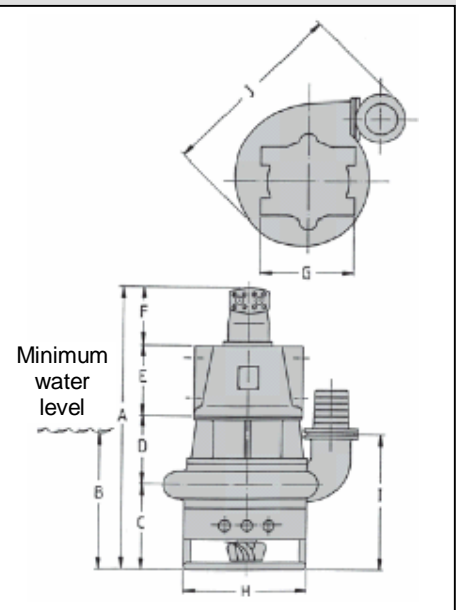

• **Concept :**

The TOYO DPH range of submersible pumps with agitator has been specially designed to handle heavy and abrasive slurries.

These centrifugal pumps with closed impeller feature a unique agitator design. This agitator lifts sediments into suspension, creating a slurry mixture. This enables the continuous pumping of media with a high concentration of solids.

Robust construction, careful selection of materials and unique contour components, coupled with a low speed high torque motor, have produced a pump with excellent abrasion resistance capable of handling the toughest of applications. These characteristics ensure long service life and economical operation.

The impeller, the wear plates and the agitator are manufactured in cast chrome iron (24 to 28 % Cr).

A strong short shaft, supported by a series of carefully selected bearings and an assembly of special lip seals, operating in an oil bath, ensure tightness in the hardest of conditions.

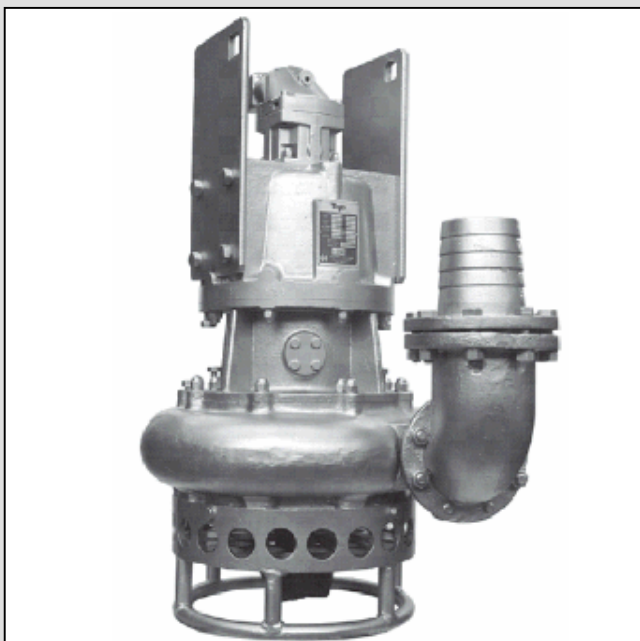

Servicing and maintaining the pumps to keep them in good working order is easy. On the DPH pumps you have two wear plates, one of which is adjustable allowing simple adjustments to maintain long lasting high performance.

A powerful hydraulic piston motor driving the DPH pumps offer the following specific characteristics :

- The speed of rotation is adjustable, which enables the pumps capacity and pressure to be adapted to suit site requirements and circumstances
- The concentration of solids in the pumped liquid can be up to 70% by weight with a maximum density of 1.4 kg/dm³

In applications where the pump is mounted onto the arm of an excavator, it can be directly connected to the excavator's hydraulic system.

As the oil from the hydraulic power pack cools the motor it allows the DPH pump to operate partially submerged. The pump cans also be used in explosive environments. These pumps are available with biodegradable oil, in different metallurgies as well as in special versions for high depths.

• **Operating conditions :**

DPH pumps can handle slurries with solid content of up to 70 % by weight, particle sizes up to 120 mm and liquid temperatures up to 60°C with pH levels between 4 and 9.5. Its standard operating depth is 30 m and maximum 120 m in special versions.

TOYO PUMPS EUROPE

Parc Industriel Sud - Zone II
 Rue de l'Industrie 41 - BE - 1400 Nivelles - Belgium
 Tel. : +32(0)67 64 55 37 - Fax : +32(0)67 64 55 31
 E-mail : sales@toyopumpseurope.com
 Website : www.toyopumpseurope.com